

SEIKA SB2i-B

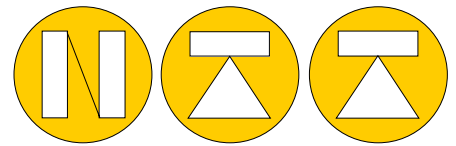

NORDIC TRANSDUCER

SB2i B1/B2/B3 & NB3 DC Acceleration

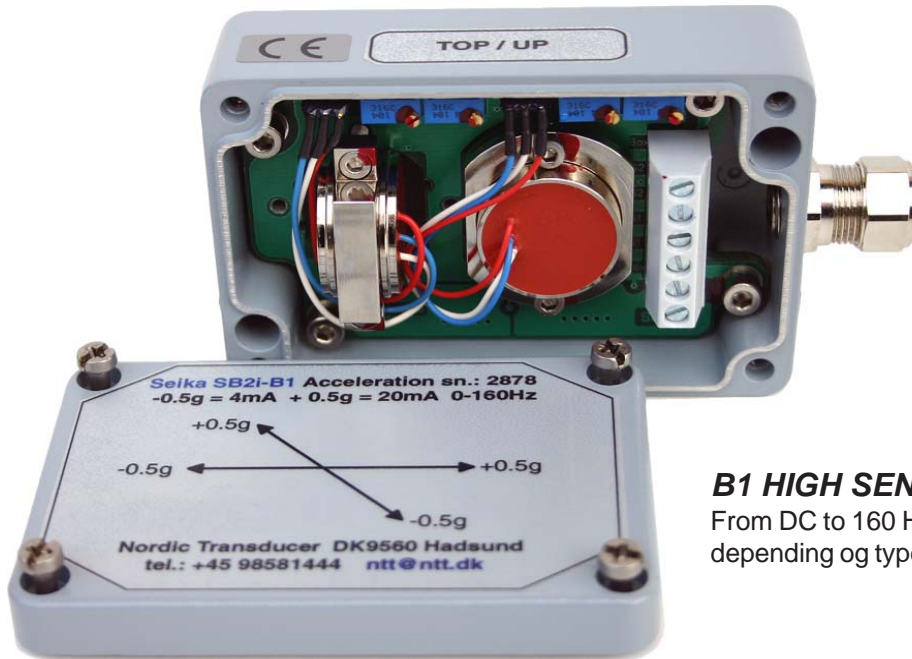

4-20mA 2 wire output
DC Acceleration

B1 HIGH SENSITIVITY ACCELERATION

From DC to 160 Hz down at +/-0.1G X Y direction depending on type of sensor used.

SB2i can also be supplied in a ATEX or CSA version including certificates for the appropriate model ! please ask !



Description

SB2i-B1, B2 & B3 (& NB3) is capacitive spring mass accelerometers with integrated sensor electronics. Resonant peaks are minimised by means of a special gas-dynamic damping in the primary transformer.

The SB2i accelerometer can be supplied in a variety of models from very high sensitive units with a very small working range down to +/-0.1G = 4-20mA output and a sensitivity at 1/10000 g

The sensor electronics requires only very low power consumption and is characterised by a high degree of long-term stability. They can be ordered with a selection of Low Pass filtering fitting to the job.

Application

The acceleration sensors **B1, B2, B3** are typically used also where high overloading occurs, from 0.5g up, in applications which require high long-term stability, measurements at a very low frequency or of static signals, very short rise-times, and/or small power consumption is required, at super sensitive measurements **NB3** are used down to a complete working range of +/- 0.1g = 4-20mA output

Typical applications are:

- **Measurement on vehicles, machines, buildings, Wind mills**
- **In process control systems as well as in safety installations**
- **Seismic measurements**
- **Inclination measurements**
- **Dynamic measurements**
- **Machine vibration measurement**
- **Dynamic rate determination**

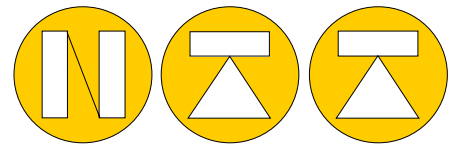

Technical Data

Termination	max.: 2 x 1,5 mm ²
Cable gland	PG M12 Size in metric metal mode
Measuring ranges	In accordance with the actual SEIKA-Sensor
Protection degree	IP65
Mounting	Any direction
Working planes sensor (B1 - B3 Sensor)	3 directions of mounting
Measuring directions (B1 - B3 Sensor)	in X,Y,Z-co-ordinate to the housing
Supply voltage to the box	+8 ... +30 Volt
Minimum loop current	3mA
Maximum loop current	Approx.24mA
Output current loop signal	4...20mA (12mA as zero point)
Adjustable area's via pot.-meters	Signal-zero (12mA), Span
Max. Load impedance	500 Ohm (at 24 Volt loop supply)
Working temperature	-40 ... +85°C

Type Sensor mounted: B1

B2

B3

	B1	B2	B3
Measuring range	±3g (app.±30m/s ²)	±10g (app.±100m/s ²)	±50g (app.±500m/s ²)
Resolution	<10 ⁻³ g	<5*10 ⁻³ g	<2*10 ⁻² g
Frequency range	0...160Hz	0...350Hz	0...550Hz
Non-linearity		<0.2% F.S.	
Cross axis sensitivity		<1%	
Sensitivity	App.2.666mA/g	app. 0.800mA /g	app. 0.160mA/g
B1 special range down to	app. 16.000mA/g (+/-0.5G range as minimum)		
Temperature drift on			
Sensitivity		<0,05% / °C	
Temperature drift on zero		<0,05mA/°C	
Mechanical overloading in measuring direction		10 000 g (app. 100 000 m/s ²)	
Nominal power supply		U _{BN} = 24 Volt (se page 3)	
Permissible range of power supply		10-30Volt (se page 3)	
Protection degree		IP65 (Optional IP67)	
Working temperature		-40°C to +85°C (optional 125°C)	
Storage temperature		-45°C to +90°C (optional 125°C)	
Weight (Metal housing without cable)		364 Gram	
Electrical standard connection		PG7 size on metric model (PG9 as optional)	
Alternative electrical connections		IP67 connector and special cables	

At order a special Low Pass filter can be ordered

Where dynamic acceleration is a demand then please look at BDK sensor at separate BDK brochure !!



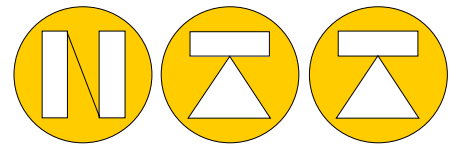

Block diagram

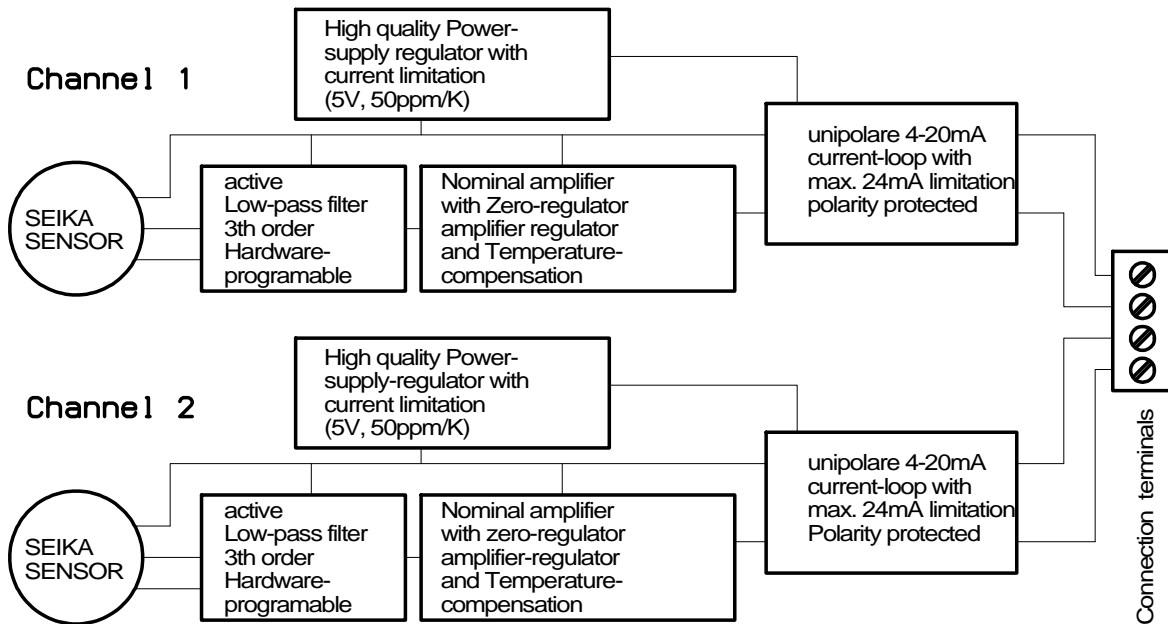

Current-Loop diagram

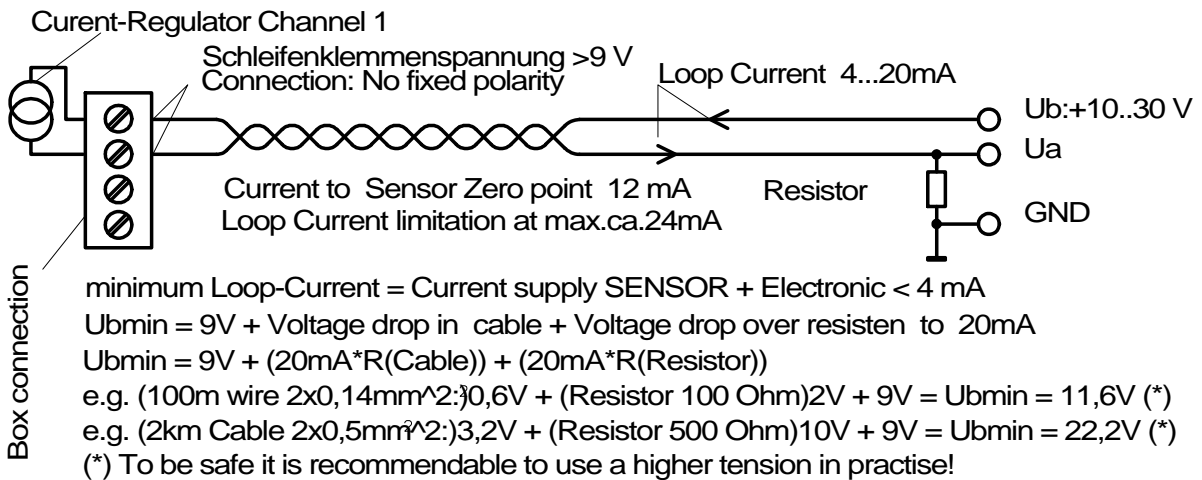

Two Current-loop's with 3 connections

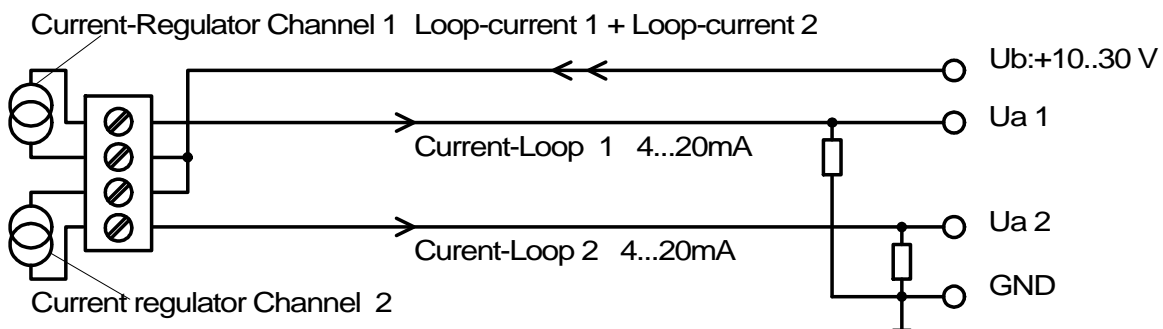

SEIKA SB2i-B

Dimensions in mm

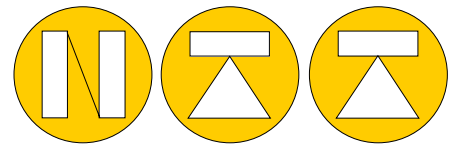

NORDIC TRANSDUCER

Page: 4

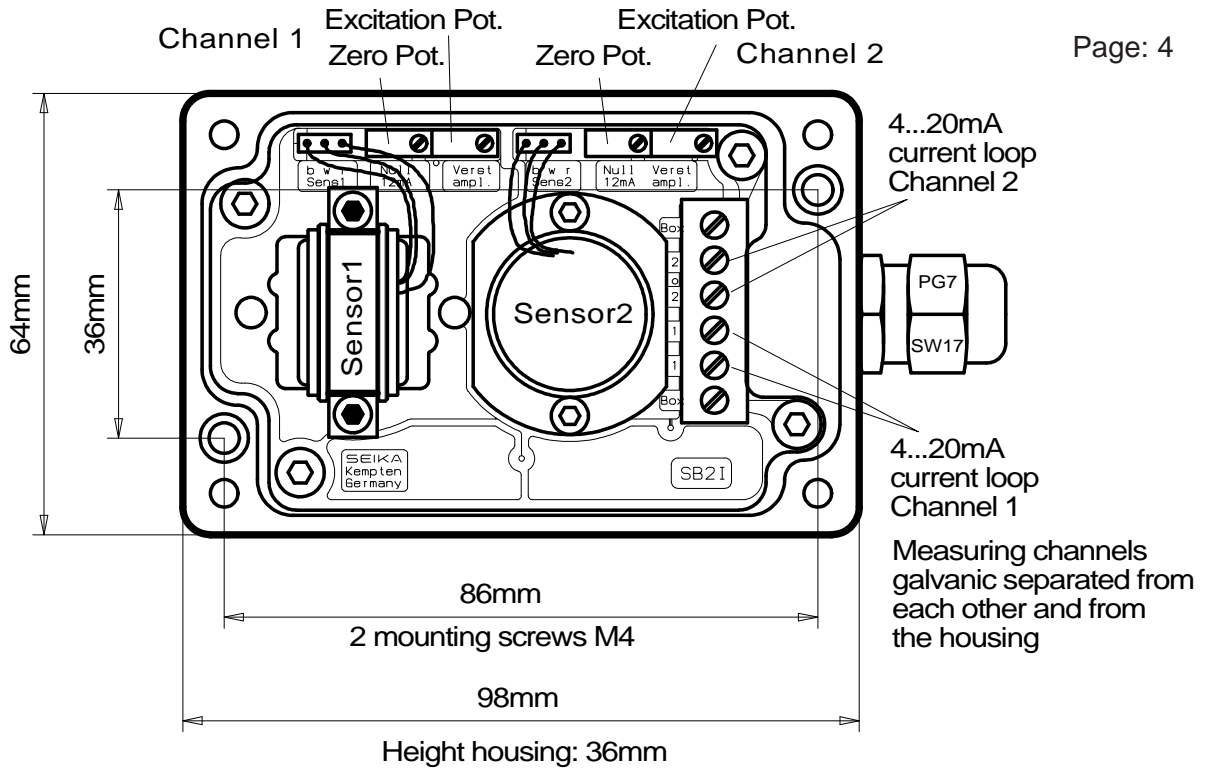

Most standard way of mounting

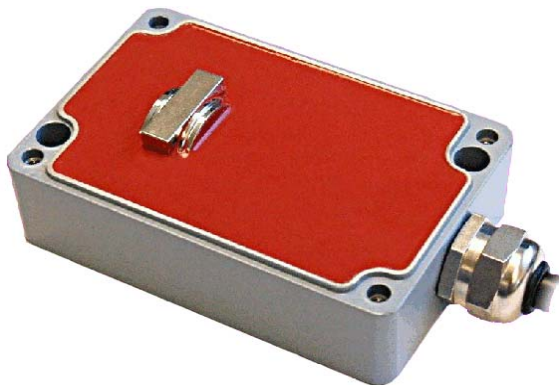

SB2i can also be complete potted inside for IP67 protection (Standard for ATEX & CSA)

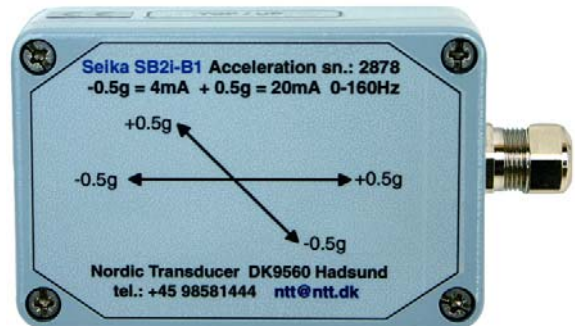

SB2i-B1-SUR-XY

ATEX certifications:

II 2G EX ia IIC T4 and II 3G Ex na IIC T4

CSA certifications:

Class I, Division 1, Groups A, B, C, D; Ex ia IIC T4 and Class I, Division 2, Groups A, B, C, D; Ex na IIC T4

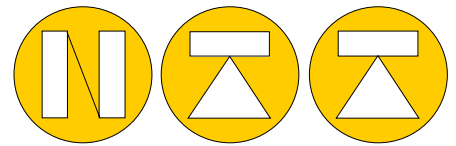

Sensor (Ch01): SB2i 2878/1
 Messbereich: -0.5g bis +0.5g Mittenstrom: 11.9994 mA Empfindlichkeit: 15.997 mA/g
 Schrittweite: 0.1g

Nordic Transducer
<http://www.ntt.dk>
 tel. +45 98581444 ntt@ntt.dk

04.02.2004 10:05

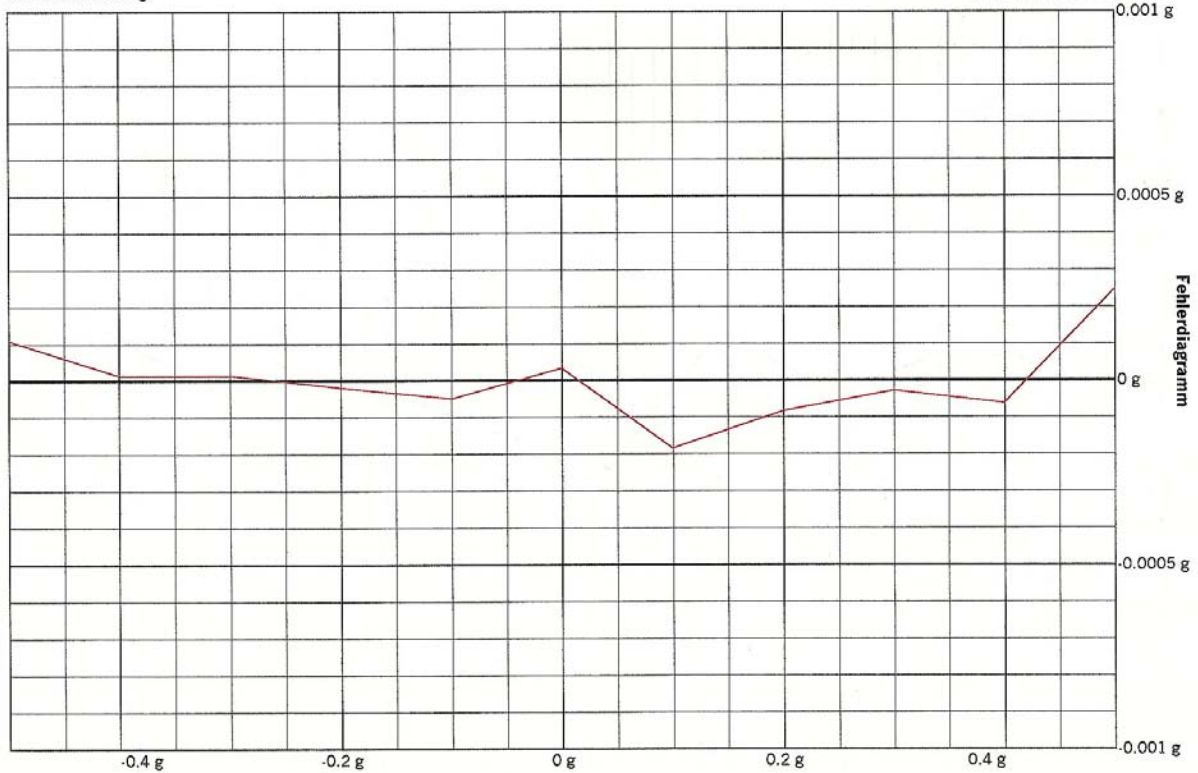

The SB2i-Bx sensor boxes can be supplied with accurate test data as shown here up to +/-1g

XB2



As option a special XB2 very strong stainless steel housing can also be supplied for the SB2i, please look at XB2 brochure for more information.

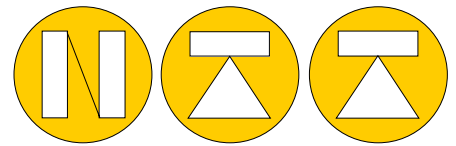

Measuring Directions

As shown here there is 5 different ways of mounting the SB2i box and each of these can be with the 2 sensors in 2 of the 3 shown directions, please notice when using Z direction the zero point will then be 1G.

The SB2i box must be fixed rigid in a level position for both X and Y axis as the zero point will be influenced by tilting, a DC accelerometer do in principle also measure inclination so it is important to level it correct.

If this is a problem then BDK sensors can be implemented, but notice that these do only go down to 1 Hz, they can be situated as you wish without changing the zero point.

Ordering example: SB2i-B1-SUR-XY

Side Up Left = **SUL**

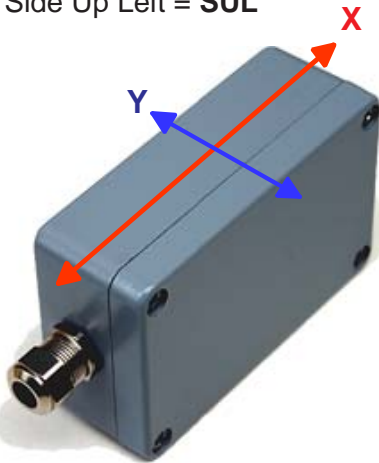

Side Up Right = **SUR**

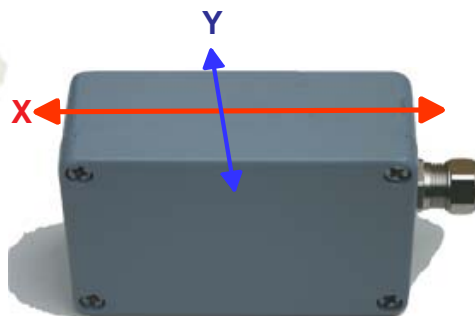

End Up = **EU**

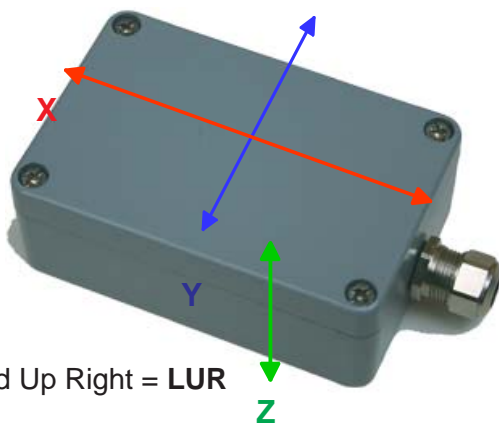
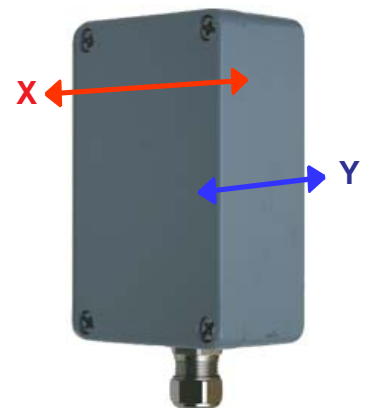

Lid Up Right = **LUR**

Lid Up Left = **LUL**

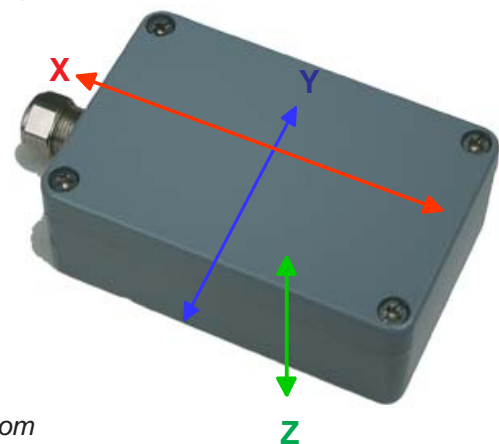

LUL-XZ
or **LUL-YZ**

Please notice: Only possible with LID UP
LUR-XZ or **LUR-YZ**

When using Z axis, 1g will be off-set which has to be deducted from sensor range, so a B1 sensor will then only have a range of +/-2g max. BDK3, BDK10 sensors will work on the full range. NB3 sensor can not be used in Z axis.

Mounting plates for SB2i box made of stainless steel

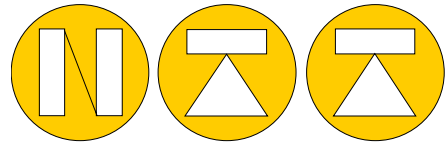

NORDIC TRANSDUCER

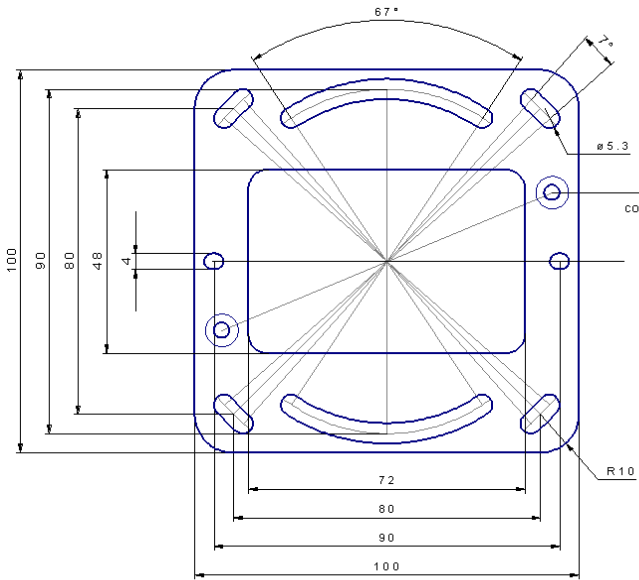

fixing holes for sensor box SB..
 counterbore for countersunk screw M4
 for the SEIKA SB-sensor box
 reference line for dowel pins

Recommended parts for mounting:
 hexagon socket-type (Allen) screw M5
 stainless steel DIN 912
 spring washers
 stainless steel DIN 127
 washers, stainless steel
 outer diameter 9...10mm DIN 433 or DIN 125

SBBS1

Material: stainless steel, thickness 3mm

SBBS1

fixing holes for sensor box SB..
 counterbore for countersunk screw
 for the SEIKA SB-sensor box

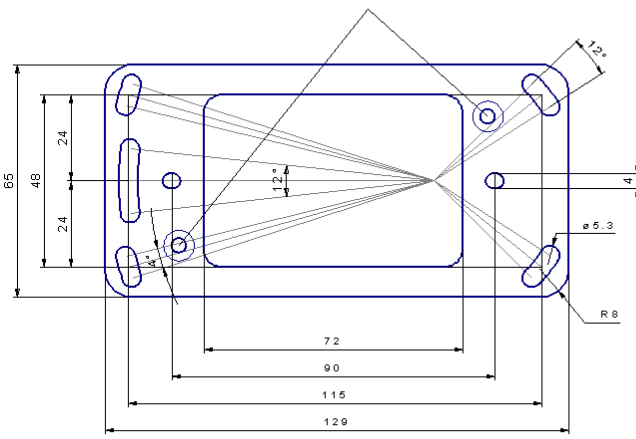

Recommended parts for mounting:
 hexagon socket-type (Allen) screw M5,
 stainless steel DIN 912
 spring washers
 stainless steel DIN 127
 washers, stainless steel
 outer diameter 9...10mm DIN 433 or DIN 125

Material: stainless steel, thickness 3mm



SBBW1

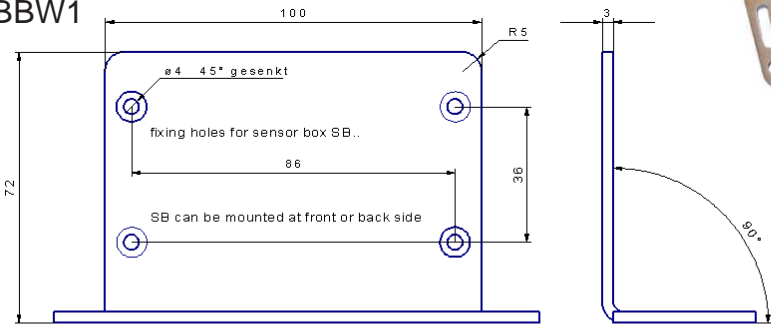

Material: stainless steel, thickness 3mm

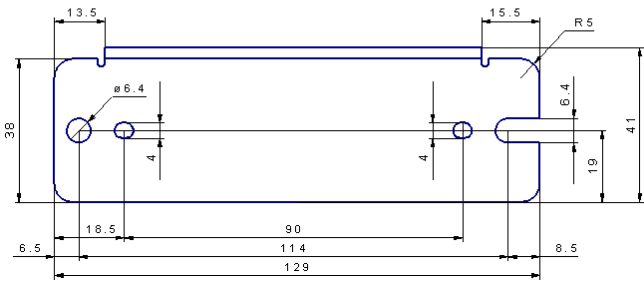

Recommended parts for mounting:
 hexagon socket-type (Allen) screw M6
 stainless steel DIN 912
 spring washers
 stainless steel DIN 127
 washers, stainless steel
 DIN 433 or DIN 125